

Pos. Nr. Pos.no.	Beschreibung Description	Art.-Nr. Art.no.	Preisgruppe Price bracket
61493	ÖBB 1670	=	
61494		=	🔊
61495		~	🔊
1	Gehäuse komplett Betr. Nr. 1670.27 Body ass. compl. Loc no. 1670.27	147835	34
2	Schraube M 2x7 mm Screw	85673	3
3	Lokpfeife Loko whistle	88002	6
4	Puffer gewölbt rechts Bufer vaulted right	98859	5
5	Puffer flach links Buffer flat left	98860	5
6	TS - Bremschläuche + Zughaken Part set of brake tubes & coupling hooks	139832	7
7	Isolatorsatz Insulators set	115359	7
8	TS - Führerstand-Himmel Parts set driver cab	147815	7
9	Kontakt Teller Litze 90 MM Contact plate braid	117357	4
10	Maschinenraumfenster Engine-rom -window	117373	7
11	Griffstangensatz Grasp bars set	117503	11
12	Dachstegsatz Gangway set	117376	8
13	Leitung Wire	117377	3
14	Zugheizkabel Pipe for heating	117378	3
15	Umlauf Gangway	117380	3
16	Isolatorgruppe vorne Isolatorgroup front	121803	5
17	Isolatorgruppe hinten Isolatorgroup behind	121804	5
18	Isolatorgruppe kurz Insulatorgroup short	121805	5
19	Isolator f. Hauptleitung Insulator for main line	121806	3
20	Klappe lackiert Cover coated	130231	6
21	Türgriff Hand rail	117387	4
22	Verschubgriff lackiert Displazement grasp coated	130230	5
23	Dachleitung lackiert Rof line coated	117389	9
24	Isolatorleitung Insulator line	117395	3
25	Kontakt Teller Litze 100 MM Contact plate braid	117499	4
26	Griff klein Grasp small	117504	3
27	Pantograph Pantograph	85399	19
28	Stirnfenster Front window	121802	6
29	Lichtnagelsatz Lens set	117372	7
30	Stromabnehmerfeder brüniert Pantograph spring browned	121807	3
31	Lichtnagel rot Lens red	112173	3
32	Hauptschalter Main switch	123641	9
33	Lichtleiter Light conductor	147836	7
34	Kontakt Teller Litze 100 MM Contact plate braid	117499	4
35	E-Lokführer Driver	110407	6

Änderungen in Konstruktion und Ausführung vorbehalten
We reserve the right to change the construction and specification

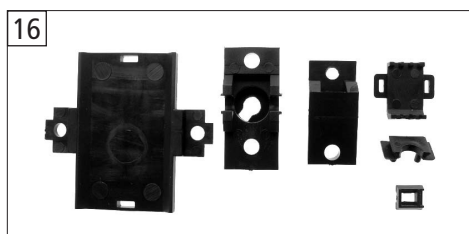
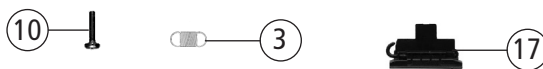
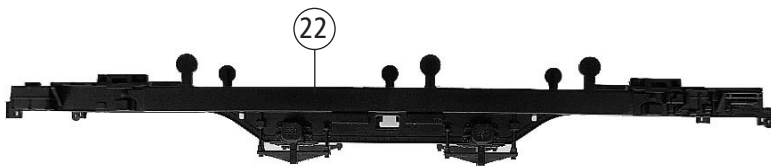
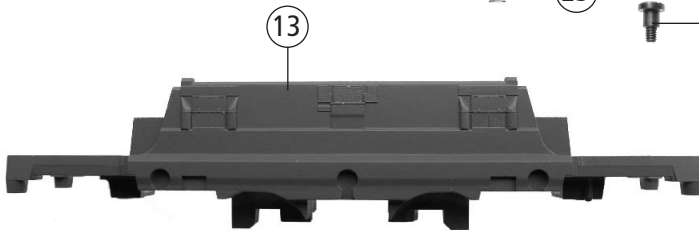
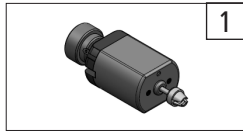
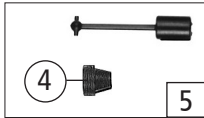
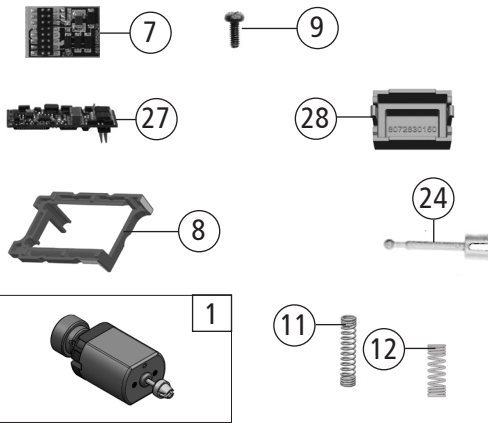
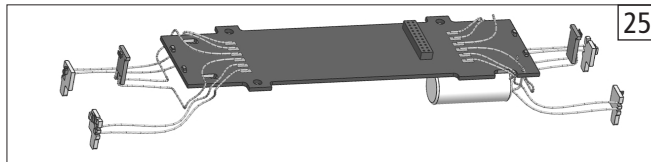
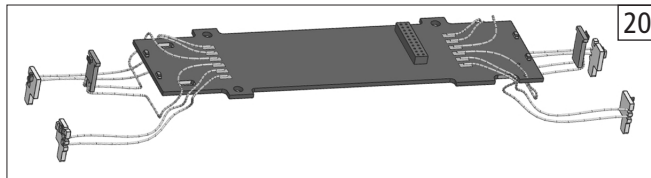

61493	ÖBB	1670	=	
61494			=	🔊
61495			~	🔊

Pos. Nr. Pos.no.	Beschreibung Description	Art.-Nr. Art.no.	Preisgruppe Price bracket
1	Motor KM Motor	149561	24
2	FK-Schraube mit Gewindeauslauf FK-Screw	85704	4
3	Zugfeder Spring	86208	3
4	Kardanschale kurz 1,5mm Cardan shell short	87129	4
5	Gelenkwelle und Kardanschale Cardan shaft and cardan reception	100075	8
6	Kurzkupplung Vorentkupplung Short coupling pre-uncoupling	115550	6
7	Brückenstecker Plux 16 Jumper	133241	10
8	Distanzplättchen Spacer	147831	6
9	GF-Schraube M2x4 mm GF-Screw	114877	3
10	GF-Schraube M1,6x8 mm GF-Screw	115037	3
11	Motorkontaktfeder lang Motor contact spring long	145560	4
12	Motorkontaktfeder kurz Motor contact spring short	145561	4
13	Grundrahmen Main frame	147813	15
14	Deichsel Holder for coupling	117348	4
15	Kupplungskammer Coupling chamber	117350	4
16	Teilesatz Parts set	117351	6
17	Indusi Indusi	117352	3
18	Auftritt Step	117353	3
19	Treppe Step	117355	3
20	Platine komplett PCB compl.	147818	21
21	Dose Socket	117379	3
22	Rahmen Frame	117345	7
23	Konusfeder Cone spring	86202	3
24	Kardanwelle Cardan shaft	107011	4
Sound			
25	Platine komplett PCB compl.	147850	21
26	Lautsprecher Loudspeaker	129524	13
27	Sounddecoder Sound-decoder	147377	39
28	Soundbox Soundbox	139681	6

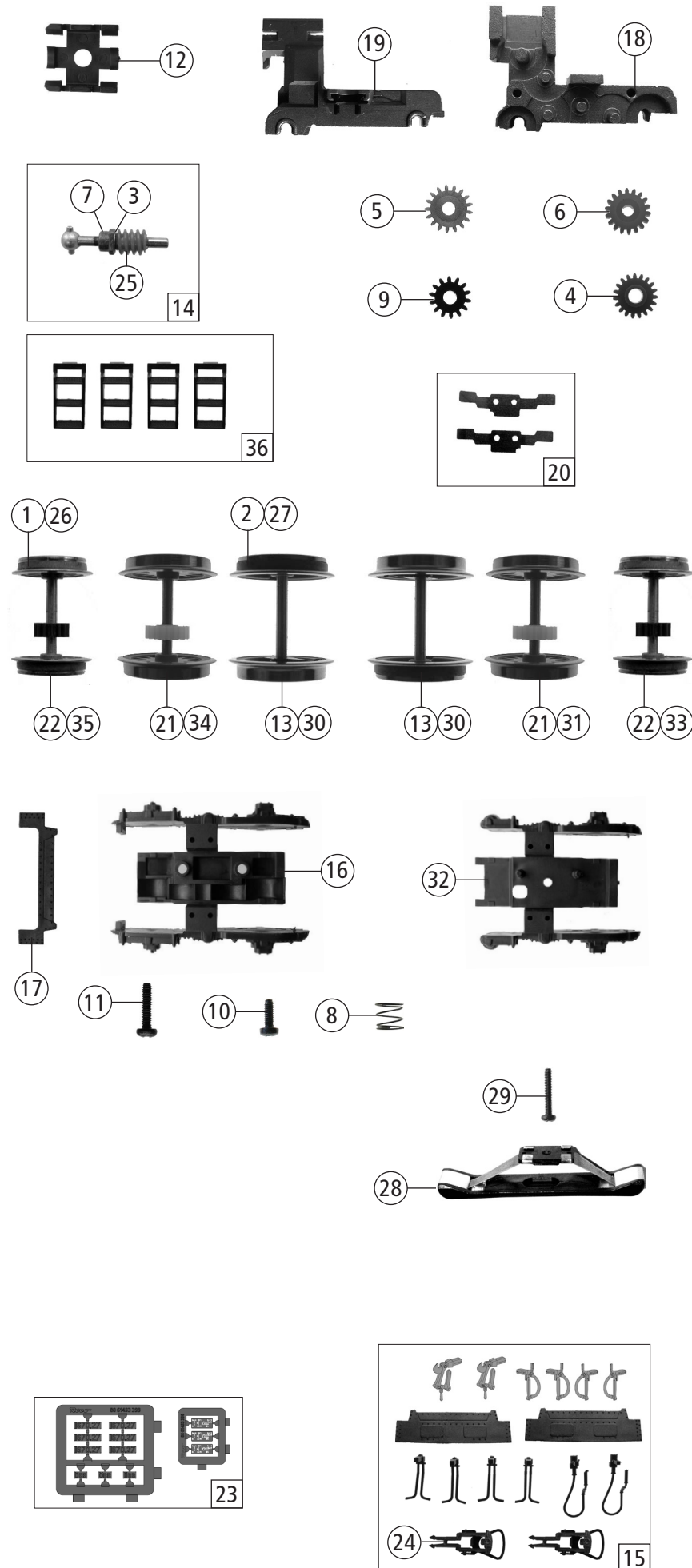

Pos. Nr. Pos.no.	Beschreibung Description	Art.-Nr. Art.no.	Preisgruppe Price bracket
61493	ÖBB 1670	=	
61494		=	🔊
61495		~	🔊
1	Haftringsatz 10Stk. 10,3-12,8mm Set with traction tires 10 pieces	40069	---
2	Haftringsatz 10Stk. 12,9-14,6mm Set with traction tires 10 pieces	40070	---
3	Beilagscheibe 2.1x4/0.2 mm Washer disk	86108	3
4	Zahnrad Z=19/14 M-0.4 Gearwheel	86416	4
5	Zahnrad Z=17/0.4 G Gearwheel	86418	5
6	Zahnrad Z=18 M-0.4 G Gearwheel	86460	3
7	Lager für Schneckenachse Bearing for Worm axle	89749	6
8	Laufstellendruckfeder Spring	108226	3
9	Zahnrad Z=14 Gearwheel	111115	3
10	GF - Schraube M2x6 mm GF - Screw	114828	3
11	GF - Schraube M2x8 mm GF - Screw	114923	3
12	Schneckendeckel Wormcover	117349	4
13	Radsatz 3+4 mit 1x Haftring Wheelset 3+4 with 1x traction tyre	117356	12
14	Schneckensatz komplett Worm set assembly	117359	13
15	Zurüstbeutel Bag with accessories	147849	13
16	Blende Bogie	117363	8
17	Frontblech ausgeschnitten Front plate cut out	117364	6
18	Getriebe Gear case	117365	10
19	Getriebedeckel Gear cover	117366	8
20	Radkontaktsatz Wheel contact set	117367	5
21	Radsatz 2+5 ohne Haftring Wheelset 2+5 without traction tyre	117368	11
22	Radsatz 1+6 klein mit Haftring Wheelset 1+6 small with traction tyre	117370	12
23	Tafelsatz lackiert Set of panels coated	147851	12
24	Standardkupplung Standard coupling	89246	6
25	Schnecke Wormgear	86703	5
AC - Wechselstrom			
26	Haftringsatz 10Stk. 10,3-12,4mm Set with traction tires 10 pieces	40074	---
27	Haftringsatz 10Stk. 12,5-15,3mm Set with traction tires 10 pieces	40075	---
28	Schleifer Slider	86030	14
29	GF - Schraube 1.6x6 mm GF - Screw	114836	3
30	AC - Mittelradsatz mit Haftring AC - Wheelset with traction tyre	117396	12
31	Radsatz AC ohne Haftring o. Zahn. Wheelset without traction tyre without gear	117397	10
32	Blende Bogie	117398	8
33	Radsatz AC klein ohne Haftring o. Zahnrad Wheelset small without traction tyre/gear	117399	10
34	Radsatz AC mit Haftring Wheelset AC with traction tyre	117400	12
35	Radsatz AC klein mit Haftring Wheelset AC small with traction tyre	117401	12
36	Zurüstbeutel Treppen Bag with accessories steps	121809	6